

SECTION A - A

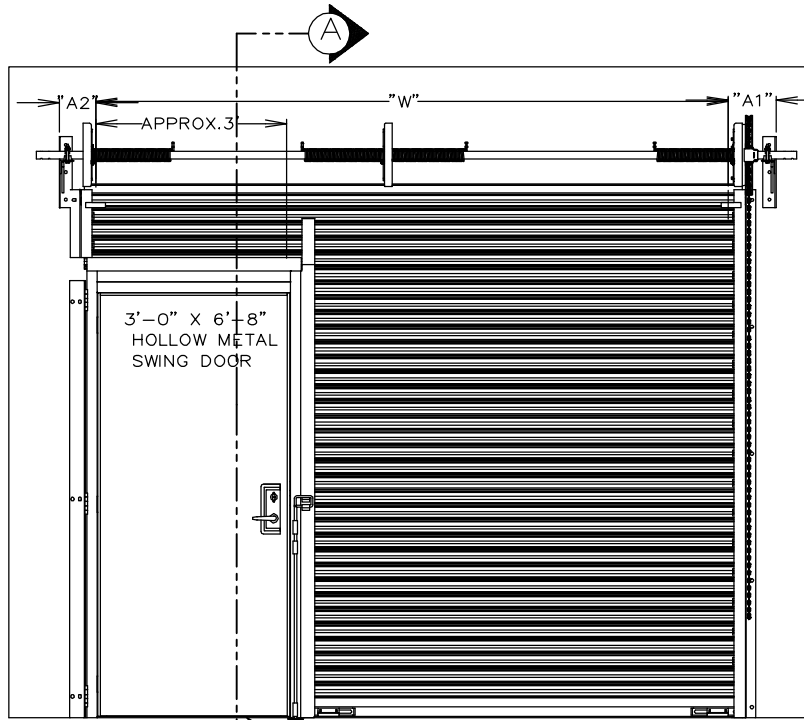

ELEVATION

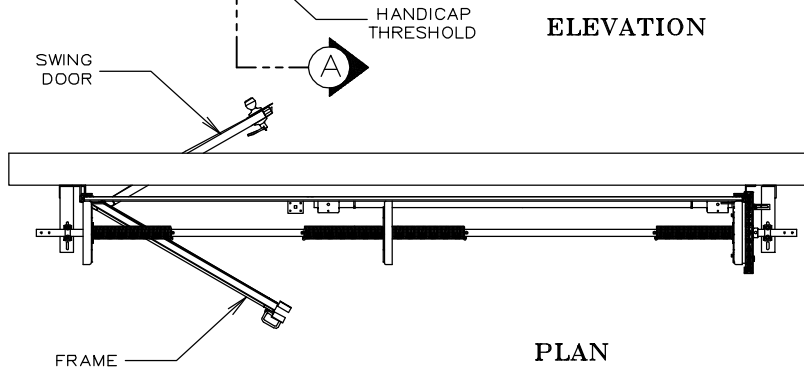

PLAN

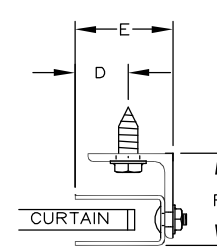

U-GUIDE FOR STEEL/WOOD

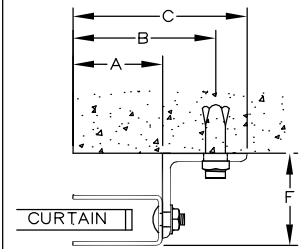

Z-GUIDE FOR CONCRETE/MASONRY

2 PC. GUIDES	A"	B"	C"	D"	E"	F"
	2 1/2	3 13/16	4 1/2	1 1/4	2 5/8	2 1/16

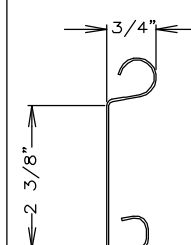

----- GAUGE

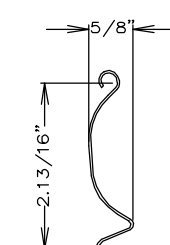

----- GAUGE

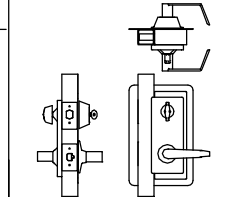

INTERCONNECTED LOCK W/INTERCHANGEABLE CORE

GENERAL NOTES

OPERATION	A1	A2
ELECTRIC OPERATION	9"	6"
CAST REDUCTION	9"	7"
ALL REDUCTION ON DOORS 14' WIDE OR WIDER	10"	7"

HOLLOW METAL DOOR

18 GAGE STEEL
INSULATED POLYSTYRENE
SLAB CORE

07-17-03

300-PASS-L

MDL.	QTY.	OPENING SIZE		OPERATION	R.H. L.H.	CLEARANCES		OPTION	PROJECT:	ARCHITECT:	CONTRACTOR:	DISTRIBUTOR:	DATE:	SHEET:	OF:	BY:	REF. #.	
		WIDTH "W"	HEIGHT "H"			"X"	"V"											



MORENO VALLEY, CA 92553
(951) 653-3727

300 SERIES - COMMERCIAL SLAT /PASS DOOR

NOTE: Porvene Doors is not responsible for improper installation procedures, structural backing, or field inspections of the project itself.

APPROVAL SIGNATURE:

DATE: